

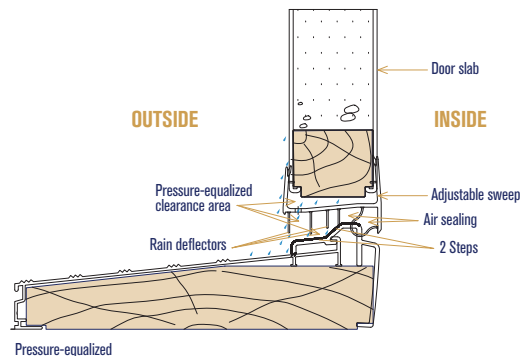

FX PATENTED B.E.S.T. CONTACT

Door sill / Sweep System



Canada and American Patented door sill system offering the best water tightness and unique pressure balance on the market

DOOR SILL / SWEEP SYSTEM

- Heavy duty bulb and fins made from premium raw material
- Low temperature resistant bulbs and fins to insure all weather flexibility
- Screwless sweep for quick and flexible installation
- "Piggy-Back" NAFS labels supplied at no charge

NAFS "FX" SYSTEM APPROVED

3 DOORS CONFIGURATIONS

- 1 Single Inswing
- 2 Single Outswing
- 3 Double Inswing

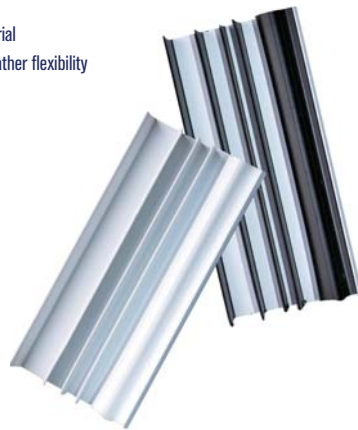

CHOICE OF THRESHOLD

- Grey exterior and white interior
- Black exterior and interior
- Black exterior and white interior

INSWING SWEEP WITH SLIDING ANODIZED CAP

- Available with black or white bulb and fins
- Exterior aluminum cap offered in black and natural anodized
- No deflection of the sweep in hot sun-light

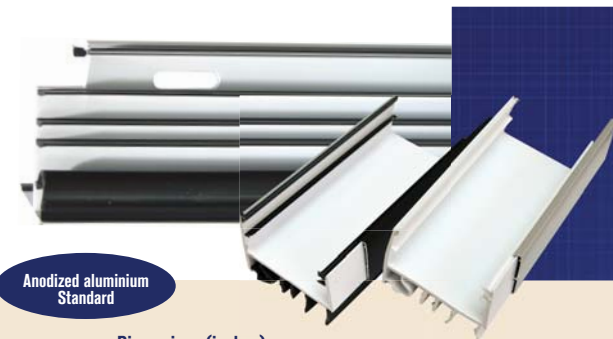

Anodized aluminium Standard

EXTENSIONS



Dimensions (inches) and colours available

	SILL	EXTENSION
Clear anodized	4 ⁵ / ₈ - 4 ⁷ / ₈ - 5 ¹ / ₄ - 6 ⁵ / ₈ 6 ⁷ / ₈ - 7 ¹ / ₄ - 8 ⁵ / ₈ - 9 ¹ / ₄ - 9 ³ / ₄	1 ¹ / ₂ - 2 - 2 ¹ / ₂ - 3 ¹ / ₂ - 4
Black anodized	4 ⁵ / ₈ - 4 ⁷ / ₈ - 6 ⁵ / ₈ 6 ⁷ / ₈ - 7 ¹ / ₄ - 9 ¹ / ₄	1 ¹ / ₂ - 2 - 3 ¹ / ₂ - 4



- Extend up to 11 1/4 width
- 4⁷/₈, 6⁷/₈, No need to notch jambs (4⁹/₁₆, 6⁹/₁₆)
- Fixed sill and adjustable sweep system
- Designed for Canadian climate VS American style adjustable sills
- Unique corner sealing system keeps out water and air

UNIQUE CORNER SEALING

- Ease of assembly
- Attractive appearance

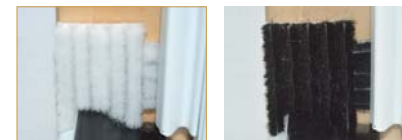

MULLION POST BLOCK

- Keeps out air and water



DOUBLE DOOR FEATURES

- Prefinished astragal
- Aluminium astragal cap available in colonial and contemporary style



Aribell Products Limited



Proudly designed in Canada

www.aribell.ca

Aribell NAFS Compliant **"FX"** Inswing and Outswing Sill/Sweep systems.
 "Piggy-back" on our test results - NAFS labels supplied at no charge.
 Full test reports now available for Masonite, Novatech and TruTech door slabs.
 Anodized clear or anodized black aluminum for better appearance.
 Extend up to **11 1/4" sill** via 7 1/4" sill with 4" extension.
 Canadian Patent # 2775167

"FX" Inswing System

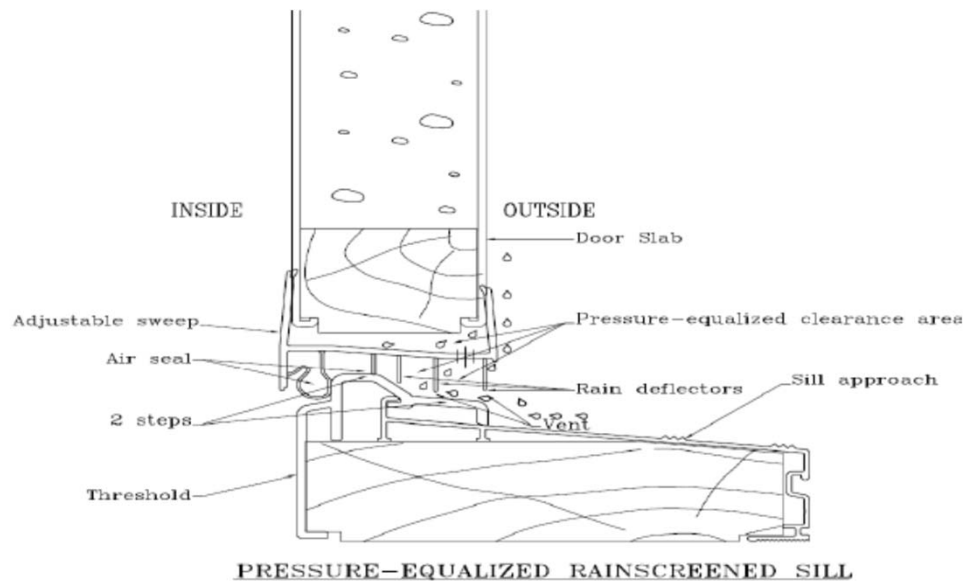
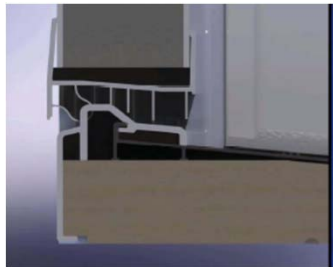
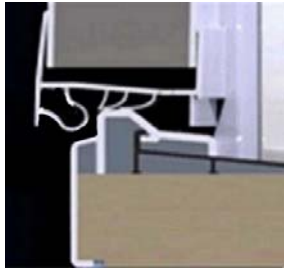

"FX" Outswing System

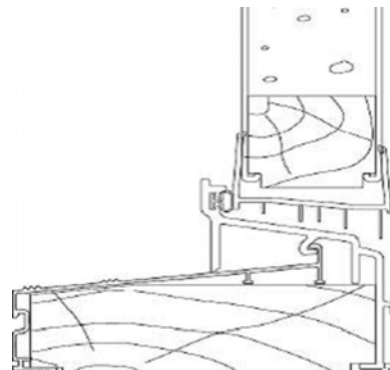
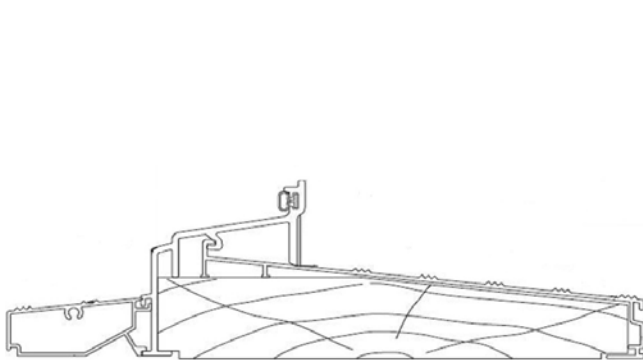

"FX" Inswing Sill ASSEMBLED w/wood subsill

Clear Anodized Aluminum

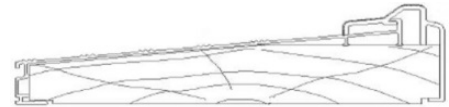

Assembled sills, with choice of PVC cap colours

Part #	Sill Width	Length		
		109"	138"	146"
FX458-xxASCLyy*	4 5/8"			N/A
FX478-xxASCLyy*	4 7/8"		N/A	
FX514-xxASCLyy*	5 1/4"			N/A
FX658-xxASCLyy*	6 5/8"			N/A
FX678-xxASCLyy*	6 7/8"		N/A	
FX714-xxASCLyy*	7 1/4"			N/A
FX858-109ASCLyy*	8 5/8"		N/A	N/A
FX914-109ASCLyy*	9 1/4"		N/A	N/A

* When Ordering: "xx" to be replaced with appropriate size: (Example: 109 for 109")

* When Ordering: "yy" PVC Cap Colour to be replaced with:

WG-White / Grey; **WB**- White / Black; **BL**-All Black

Black Anodized Aluminum

Assembled sills, with Black PVC cap



Part #	Sill Width	Length		
		109"	138"	146"
FX458-xxASBL*	4 5/8"			N/A
FX478-xxASBL*	4 7/8"		N/A	
FX658-xxASB*	6 5/8"			N/A
FX678-xxASBL*	6 7/8"		N/A	
FX714-xxASBL*	7 1/4"			N/A
FX914-109ASBL*	9 1/4"		N/A	N/A

* When Ordering: "xx" to be replaced with appropriate size: (Example: 109 for 109")

Extensions for "FX" Sills

Note: Each extension fits any of the 4 5/8"; 4 7/8"; 5 1/4"; 6 5/8"; 6 7/8" or 7 1/4" INSWING sills.

Note: These extensions also fit the FX OUTSWING sills.

Note: All extensions are sold in 148" lengths.

1.5" (FXEXT15)



2" (FXEXT2)



2.5" (FXEXT25)



3.5" (FXEXT35)



4" (FXEXT4)

Part #	Width	Length	Finish	Box Qty
FXEXT15-CA148	1 1/2"	148"	Clear	12
FXEXT15-BL148	1 1/2"	148"	Black	12
FXEXT2-CA148	2"	148"	Clear	12
FXEXT2- BL148	2"	148"	Black	12
FXEXT25-CA148	2 1/2"	148"	Clear	6
FXEXT35-CA148	3 1/2"	148"	Clear	6
FXEXT35-BL148	3 1/2"	148"	Black	6
FXEXT4- CA148	4"	148"	Clear	6
FXEXT4- BL148	4"	148"	Black	6

"FX" Outswing Sill ASSEMBLED

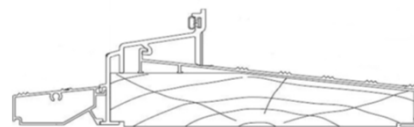

Clear Anodized Aluminum/ Grey PVC Cap

Part #	Sill Width	Length					
		30"	32"	34"	36"	42"	109"
FXO/S458-xxASCL*	4 5/8"						
FXO/S478-xxASCL*	4 7/8"						
FXO/S525-xxASCL*	5 1/4"						
FXO/S658-xxASCL*	6 5/8"						
FXO/S678-xxASCL*	6 7/8"						
FXO/S714-xxASCL*	7 1/4"						
FXOS/858-xxASCL	8 5/8"						
FXO/S914-xxASCL*	9 1/4"						

Black Anodized Aluminum/ Grey PVC Cap

Part #	Sill Width	Length					
		30"	32"	34"	36"	42"	109"
FXO/S458-xxASBL*	4 5/8" sill						
FXO/S478-xxASBL*	4 7/8" sill						
FXO/S658-xxASBL*	6 5/8" sill						
FXO/S678-xxASBL*	6 7/8" sill						
FXO/S714-xxASBL*	7 1/4" sill						
FXO/S914-xxASBL*	9 1/4" sill						

* When Ordering, xx to be replaced with appropriate size: (Example: 32 for 32")

"FX" Sill Components

FX478



FX458;FX514;FX658;FX678;FX714



FX858; FX914



Aluminum Only

Part #	Description	Finish	Length	
FX458-CA140AL	4 5/8" aluminum	Clear Anodized	140"	
FX458-BL140AL	4 5/8" aluminum	Black Anodized	140"	
FX478-CA148AL	4 7/8" aluminum	Black Anodized	148"	
FX478-BL148AL	4 7/8" aluminum	Clear Anodized	148"	
FX514-CA140AL	5 1/4" aluminum	Clear Anodized	140"	
FX658-CA140AL	6 5/8" aluminum	Clear Anodized	140"	
FX658-BL140AL	6 5/8" aluminum	Black Anodized	140"	
FX678-CA148AL	6 7/8" aluminum	Clear Anodized	148"	
FX678-BL148AL	6 7/8" aluminum	Black Anodized	148"	
FX714-CA140AL	7 1/4" aluminum	Clear Anodized	140"	
FX714-BL140AL	7 1/4" aluminum	Black Anodized	140"	
FX858-CA140AL	8 5/8" aluminum	Clear Anodized	148"	
FX914-CA140AL	9 1/4" aluminum	Clear Anodized	148"	
FX914-BL148AL	9 1/4" aluminum	Black Anodized	148"	

PVC Cap Only-Inswing

Part #	Description	Finish	Length	Box Qty	_____
FXCAP-xx74*	Inswing Cap	WG or WB or BL	74"	10	
FXCAP-xx109*	Inswing Cap	WG or WB or BL	109"	10	
FXCAP-xx146*	Inswing Cap	WG or WB or BL	146"	10	

* When ordering please replace "xx" with cap colour:

WG - White / Grey; **WB** - White / Black; **BL**- all Black

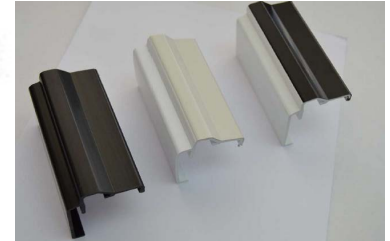
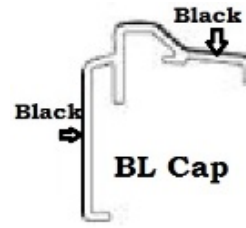
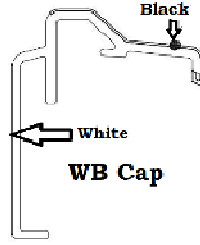
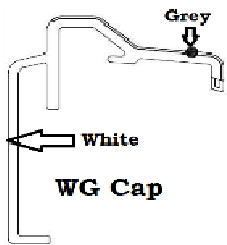

PVC Cap Only-Outswing

Part #	Description	Finish	Length	Box Qty	_____
FXCAPO/S-GR74	Outswing Cap	Grey	74"	7	
FXCAPO/S-GR109	Outswing Cap	Grey	109"	7	
FXCAPO/S-GR146	Outswing Cap	Grey	146"	7	



Wood Sub-sill Only

Part #	Description	Length	_____
FX458-SUB109	For use with FX 4-5/8" or 4-7/8" sills	109"	
FX658-SUB109	Sub Sill for all other FX sills	109"	

Outswing Weather Stripping

Part #	Description	Length	_____
FX-O/SWEATHER	weather stripping for "FX" outswing sill	150'/Roll	

Sweeps "FX" NAFS Compliant System

Inswing Sweeps

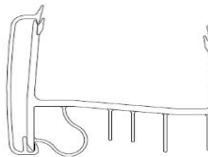
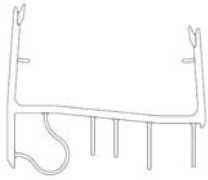

Part #	Description	Colour	Size	Pcs/Box	
FXSW-30	Inswing - White with White Fin	White	29 3/4"	24	
FXSW-32	Inswing - White with White Fin	White	31 3/4"	24	
FXSW-34	Inswing - White with White Fin	White	33 3/4"	24	
FXSW-36	Inswing - White with White Fin	White	35 3/4"	24	
FXSW-42	Inswing - White with White Fin	White	41 3/4"	24	
FXSW-74	Inswing - White with White Fin	White	109"	10	
FXSWB-30	Inswing - White with Black Fin	White	29 3/4"	24	
FXSWB-32	Inswing - White with Black Fin	White	31 3/4"	24	
FXSWB-34	Inswing - White with Black Fin	White	33 3/4"	24	
FXSWB-36	Inswing - White with Black Fin	White	35 3/4"	24	
FXSWB-42	Inswing - White with Black Fin	White	41 3/4"	24	
FXSWB-74	Inswing - White with Black Fin	White	109"	10	

Interior Screw Covers



Part #	Description	Colour	Size	Pcs/Box	
FXSWCAP-36	Interior Screw Cover	White	35 3/4"	24	
FXSWCAP-42	Interior Screw Cover	White	41 3/4"	24	
FXSWCAP-109	Interior Screw Cover	White	109"	24	

Exterior Aluminum Covers



Part #	Description/Finish	Size	Pcs/Box	
FXSWCAPEX-36	Aluminum Cap, Clear Anodized	34 11/16"	24	
FXSWCAPEX-111	Aluminum Cap, Clear Anodized	111"	20	
FXSWCAPEXBL-36	Aluminum Cap, Black Anodized	34 11/16"	24	
FXSWCAPEBL-111	Aluminum Cap, Black Anodized	111"	20	

Outswing Sweeps

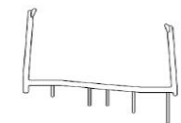

Part #	Description	Colour	Size	Pcs/Box	
FXO/SSW-30	Outswing Sweep	White	29 3/4"	24	
FXO/SSW-32	Outswing Sweep	White	31 3/4"	24	
FXO/SSW-34	Outswing Sweep	White	33 3/4"	24	
FXO/SSW-36	Outswing Sweep	White	35 3/4"	24	
FXO/SSW-42	Outswing Sweep	White	41 3/4"	24	
FXO/SSW-109	Outswing Sweep	White	109"	10	

Double Door Sweep -For Fixed Door and extends under Astragal / notched for RH or LH



Part #	Description	Colour	Size	Pcs/Box	
FXDDSW-32-xx*	Astragal Sweep	White	32 3/8"	10	
FXDDSW-34-xx*	Astragal Sweep	White	34 3/8"	10	
FXDDSW-36-xx*	Astragal Sweep	White	36 3/8"	10	
FXDDSW-42-xx*	Astragal Sweep	White	42 3/8"	10	
FXDDSWB-32-xx*	Astragal Sweep	Black fins	32 3/8"	10	
FXDDSWB-34-xx*	Astragal Sweep	Black fins	34 3/8"	10	
FXDDSWB-36-xx*	Astragal Sweep	Black fins	36 3/8"	10	
FXDDSWB-42-xx*	Astragal Sweep	Black fins	42 3/8"	10	

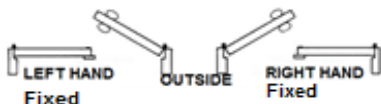

* When ordering, replace "xx" with **LH** for sweep on LEFT HAND fixed door and replace "xx" with **RH** for sweep on RIGHT HAND fixed door.

Corner Seals "FX" NAFS Compliant System

Inswing Corner Seal

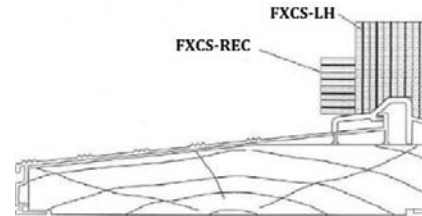
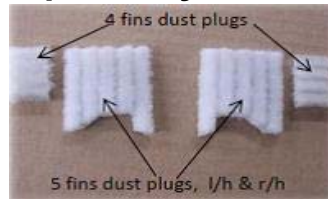

Part #	Description	Pcs/Box	
FXCS-LH	Corner seal LH Inswing	100	
FXCS-RH	Corner seal RH Inswing	100	
FXCS-REC	Corner seal rectangular (2 pieces)	100	
FXCS-KIT-SD-IS	LH+RH+2 rectangular Inswing	100	

Also available in Black

Outswing Corner Seal



FX-5231 LH

FX-5230 RH

Part #	Description	Pcs/Box	
FX-5230	Corner Seal RH Outswing	100	
FX-5231	Corner Seal LH Outswing	100	
FX-KIT-SD-OS	Corner Seal RH+LH Outswing	100	

Mullion Post Block "FX" NAFS Compliant System

Part #	Description	Pcs/Box	
FXMULLPBLOCK	White PVC block for 4-5/8" Mull Post or Back to Back Jamb	Each	

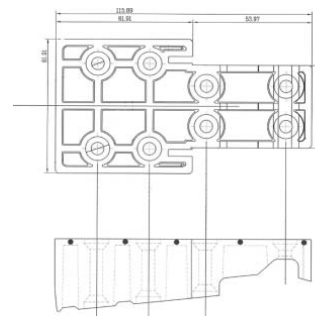
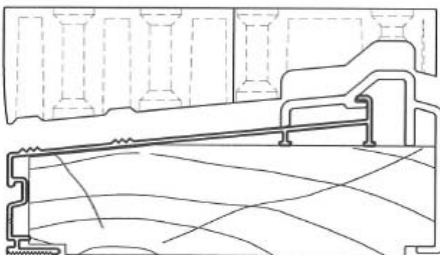

Double Door "FX" NAFS Compliant System

Astragal

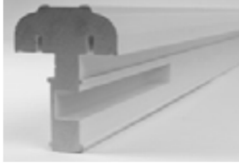



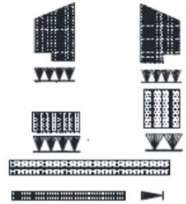

Part #	Description	Size	Colour	Pcs/Box	
FXASTFOAM-LH	FX-Foam Astragal	79"	White	10	
FXASTFOAM-RH	FX-Foam Astragal	79"	White	10	
FXASTFOAM95-LH	FX-Foam Astragal	95"	White	10	
FXASTFOAM95-RH	FX-Foam Astragal	95"	White	10	

Astragal Corner Seal Kit



Part #	Description	Kits/Box	
FX-CSKIT-AST-IS-L	Corner Seal Kit for Double Door Astragal LH	20	
FX-CSKIT-AST-IS-R	Corner Seal Kit for Double Door Astragal RH	20	

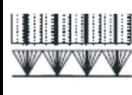
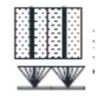



Kit Includes

Part #	Description	Kits/Box	
FX-5220LH	LH corner seal	1	
FX5221RH	RH corner seal	1	
FX-5222	Up & Down astragal corner seal	4	
FX-5223	Top of astragal corner seal	1	
FX-5224	Under sweep & on sill corner seal	2	
FX-5225	On polyflex corner seal	1	

Astragal Block Kit

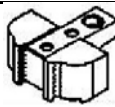

Part #	Description	Kits/Box	
FXAST-BLOCK-KIT	Astragal Block kit	20	

Kit Includes

Part #	Description	Kits/Box	
FX-5300	Astragal Block	1	
FX-5302	Flush Bolt striker for astragal block	1	
FX-5303	Flush bolt striker for under astragal	1	
FX-5304	Flush bolt striker for astragal top	1	
FX-572-CP	Weatherstrip for astragal block	1	

Astragal Accessories

Astragal Cover "Colonial" - Extruded Aluminum (White Only)

	Part #	Description	Size	Pcs/Box	
	FX-519-WHB-79	Astragal cover - Aluminum	79"	10	
	FX-519-WHB-95	Astragal cover - Aluminum	95"	10	
	FX-519-WHB-25	Astragal Block cover -	1"	1	
	FX-520-WH-79	Astragal Extension for screen	79"	1	
	FX-520-WH-25	Astragal Block cover extension	1"	1	

Astragal Cover "Contemporary" - Extruded Aluminum (White, Black or Brown)

	Part #	Description	Size	
	FX-541-WHB-79*	Astragal cover - Aluminum	79"	
	FX-541-WHB-95*	Astragal cover - Aluminum	95"	
	FX-541-WHB-25*	Astragal Block cover	1"	

* When ordering specify "xxx" as: **WB** for White; **BL** for Black, or **CB** for Commercial Brown

Flush Bolt

Part #	Description	Qty	
FX-FBSIL	Flush Bolt, Satin Chrome Finish	1	

